

EPIC-5536

AMD Geode LX 800/900
(500/600MHz) Processors

DDR SODIMM Up to 1GB

Up to 24-bit TFT/LVDS LCD Panel

4 USB 2.0 / 5 COMs / 1 IDE/

2 SATAI/ 1 CompactFlash/ Digital I/O

Copyright Notice

This document is copyrighted, 2008. All rights are reserved. The original manufacturer reserves the right to make improvements to the products described in this manual at any time without notice.

No part of this manual may be reproduced, copied, translated, or transmitted in any form or by any means without the prior written permission of the original manufacturer. Information provided in this manual is intended to be accurate and reliable. However, the original manufacturer assumes no responsibility for its use, or for any infringements upon the rights of third parties that may result from its use.

The material in this document is for product information only and is subject to change without notice. While reasonable efforts have been made in the preparation of this document to assure its accuracy, AAEON assumes no liabilities resulting from errors or omissions in this document, or from the use of the information contained herein.

AAEON reserves the right to make changes in the product design without notice to its users.

Acknowledgments

All other products' name or trademarks are properties of their respective owners.

- Award is a trademark of Award Software International, Inc.
- CompactFlash™ is a trademark of the Compact Flash Association.
- AMD, the AMD Arrow logo and combinations thereof are trademarks of Advanced Micro Devices, Inc.
- Microsoft Windows® is a registered trademark of Microsoft Corp.
- ITE is a trademark of Integrated Technology Express, Inc.
- IBM, PC/AT, PS/2, and VGA are trademarks of International Business Machines Corporation.

All other product names or trademarks are properties of their respective owners.

Packing List

Before you begin installing your card, please make sure that the following materials have been shipped:

- 1 9657666600 Jumper Cap
- 1 9681945600 Cable Kit for EPIC-5536
- 1 EPIC-5536 CPU Board w/ Heatsink
- 1 Quick Installation Guide
- 1 CD-ROM for manual (in PDF format) and drivers

If any of these items should be missing or damaged, please contact your distributor or sales representative immediately.

Contents

Chapter 1 General Information

1.1 Introduction.....	1-2
1.2 Features	1-3
1.3 Specifications	1-4

Chapter 2 Quick Installation Guide

2.1 Safety Precautions	2-2
2.2 Location of Connectors and Jumpers	2-3
2.3 Mechanical Drawing	2-5
2.4 List of Jumpers	2-7
2.5 List of Connectors	2-8
2.6 Setting Jumpers	2-10
2.7 CFD1 Selection (JP1).....	2-11
2.8 ATX Simulates AT Power (JP2)	2-11
2.9 CMOS Clear Selection (JP3)	2-11
2.10 COM2 +12V/+5V/Ring Selection (JP4)	2-11
2.11 LCD Inverter Power Selection (JP5)	2-11
2.12 TTL Clock and LVDS Operating Selection (JP6)	2-12
2.13 FAN Power Selection (JP7)	2-12
2.14 AT/ATX Power Type Selection (JP8)	2-12
2.15 LCD Backlight Control (JP9)	2-12
2.16 DDR SODIMM Connector (CN1)	2-12
2.17 LPT Connector (CN2).....	2-13

2.18 PC/104 Connector (CN3)	2-13
2.19 PCI-104 Connector (CN4)	2-13
2.20 COM1/2 Connector (CN5).....	2-14
2.21 Power Connector (CN6).....	2-14
2.22 LVDS Connector (CN9).....	2-15
2.23 Keyboard/Mouse Connector (CN10).....	2-15
2.24 IrDA Connector (CN11)	2-16
2.25 COM3 Connector (CN12).....	2-16
2.26 COM4 Connector (CN13).....	2-16
2.27 System Fan Connector (CN14).....	2-17
2.28 Front Panel Connector (CN15)	2-17
2.29 Digital I/O Connector (CN16)	2-17
2.30 TTL LCD Connector (CN17)	2-18
2.31 LCD Inverter Power Connector (CN18)	2-19
2.32 Floppy Connector (CN19)	2-19
2.33 COM5/ GPS Connector (CN20).....	2-20
2.34 Power Output Connector (CN21)	2-20
2.35 Audio Line-in Connector (CN23).....	2-21
2.36 Battery Wafer (CN24).....	2-21
2.37 CompactFlash Connector (CN25).....	2-21
2.38 IDE Connector (CN26)	2-21
2.39 SATA Connectors (CN27, CN28).....	2-22
2.40 VGA Connector (CN29)	2-22
2.41 Standby Power Connector (CN30).....	2-23

Chapter 3 Award BIOS Setup

3.1 System Test and Initialization	3-2
3.2 Award BIOS Setup	3-3

Chapter 4 Driver Installation

4.1 Installation	4-3
------------------------	-----

Appendix A Programming The Watchdog Timer

A.1 Programming	A-2
A.2 ITE8712 Watchdog Timer Initial Program.....	A-5

Appendix B I/O Information

B.1 I/O Address Map	B-2
B.2 1 st Memory Address Map.....	B-2
B.3 IRQ Mapping Chart.....	B-3
B.4 DMA Channel Assignments.....	B-3

Appendix C Mating Connector

C.1 List of Mating Connectors and Cables.....	C-2
---	-----

Chapter

1

**General
Information**

1.1 Introduction

AAEON announces the first EPIC Board-EPIC-5536, designed to fit in diverse applications that demand for fitting in different space limitations and fanless environment.

EPIC-5536 accommodates onboard AMD Geode LX800/900 (500/600MHz) processor or optional LX700 processor. This model features 200-pin DDR SODIMM and system memory is up to 1GB for DDR 333 or 512MB for DR400. Moreover, EPIC-5536 adopts AMD LX series and CS5536 as its chipset.

EPIC-5536 deploys Realtek 8100C 10/100Base-TX chip that features two RJ-45 ports or optional RTL 8110S Gigabit LAN to display the transcendent performance of network connections. This new EPIC Board configures an AMD Geode LX and TI SN75 LVDS 83 chipset to support CRT/LCD simultaneous display.

In addition, EPIC-5536 deploys the PC/104+ that is PC/104 and PCI-104 expansions. Moreover, EPIC-5536 also features one EIDE, two SATA I, one Type II CompactFlash for the storage and four USB 2.0 ports, five COM ports, 8-bit Digital I/O for flexible I/O expansions. EPIC-5536 is the first choice for your essential applications.

1.2 Features

- Onboard AMD Geode LX 800/900 Processors
- SODIMM DDR 333 Max. 1GB and DDR400 Max. 512MB
- Up to 24-bit TTL/LVDS LCD Panel
- Dual 10/100Base-TX Ethernet (Optional Gigabit LAN)
- AC97 2.0 Codec 2 CH Audio
- PC/104+ Socket Expansions
- SATA I with RAID 0, 1
- Digital I/O (8-bit Programmable)
- LCD Inverter Power Connector

1.3 Specifications

System

- CPU Onboard AMD Geode LX800/900 (500/600MHz) processors (Optional LX 700)
- System Memory 200-pin DDR SODIMM x 1, max. 1GB for DDR333 & 512MB for DDR 400
- Chipset AMD LX series + CS5536
- I/O Chipset ITE IT 8712 + Fintek F81216DG
- Ethernet Realtek 8100C 10/100Mb Chip, RJ-45 x 2 (Optional RTL 8110S Gigabit LAN)
- BIOS Award Plug & Play BIOS – 1 MB ROM
- Watchdog Timer Generates a time-out system reset
- Wake on LAN Yes
- H/W status monitoring Supports power supply voltage, fan speed and temperature monitoring unctions
- Expansion Interface PC/104+ (PC/104 + PCI-104)
- Battery Lithium battery
- Power Requirement +12V, AT/ATX
- Operating Temperature 32°F~140°F (0°C~60°C)

- Storage Temperature -40°F~176°F (-40°C~80°C)
- Operating Humidity 0%~90% relative humidity, non-condensing
- MTBF (Hours) 70,000
- Board Size 4.53"(L) x 6.5" (W)
(115mm x 165mm)
- Gross Weight 1.2 lb (0.5kg)

Display: Support: CRT/LCD simultaneous display

- Chipset AMD Geode LX + TI SN75
LVDS 83
- Memory Shared system memory up to 254MB
- Resolutions Up to 1920 x 1440 @ 24-bit for CRT; Up to 1600 x 1200 @ 24-bit for LCD
- LCD Interface Up to 24-bit dual-channel
TTL/LVDS TFT LCD (18/24-bit single channel LVDS is configured by manufacturer)
- LCD Inverter Yes, 5V or 12V

I/O

- Storage EIDE x 1 (UDMA100), SATA I x 2, Type II CompactFlash x 1

- Serial Port RS-232 x 3, COM TTL only/
GPS x 1, RS-232/422/485 x 1
- Parallel Port SPP/ EPP/ ECP mode
- USB USB 2.0 x 4
- PS/2 Port Keyboard + Mouse x 1
- Digital I/O Supports 8-bit (Programmable)
- IrDA Optional one IrDA Tx/Rx header
- Audio Line-in, Line-out & MIC-in

Chapter

2

**Quick
Installation
Guide****Notice:**

The Quick Installation Guide is derived from Chapter 2 of user manual. For other chapters and further installation instructions, please refer to the user manual CD-ROM that came with the product.

2.1 Safety Precautions

Warning!

Always completely disconnect the power cord from your board whenever you are working on it. Do not make connections while the power is on, because a sudden rush of power can damage sensitive electronic components.

Caution!

Always ground yourself to remove any static charge before touching the board. Modern electronic devices are very sensitive to static electric charges. Use a grounding wrist strap at all times. Place all electronic components on a static-dissipative surface or in a static-shielded bag when they are not in the chassis

2.2 Location of Connectors and Jumpers

Component Side

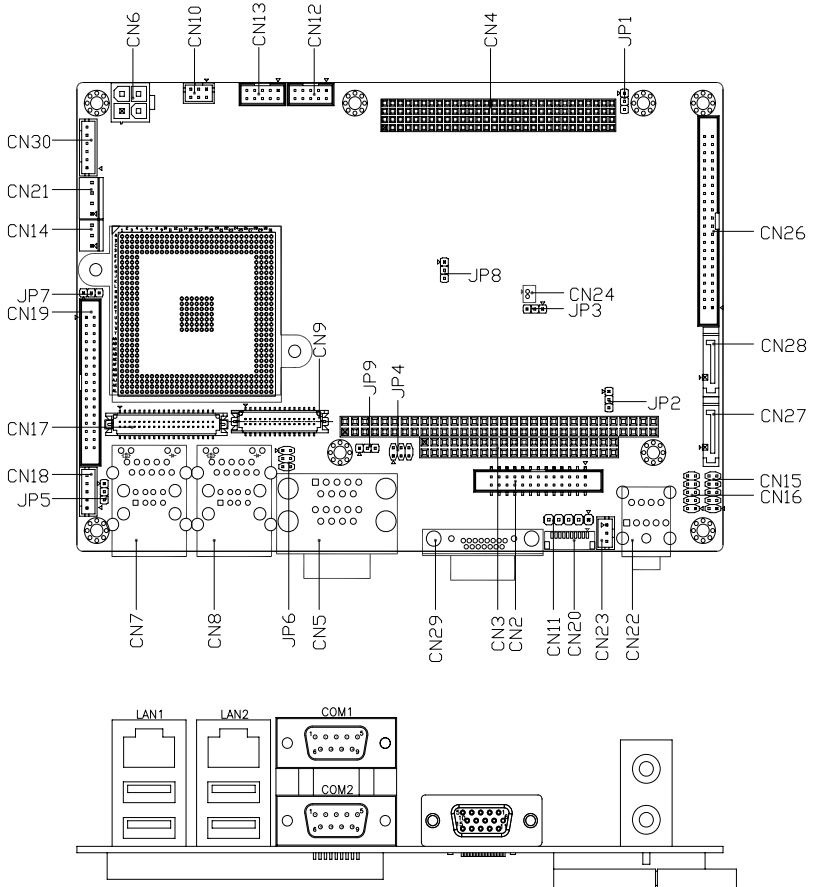

Solder Side

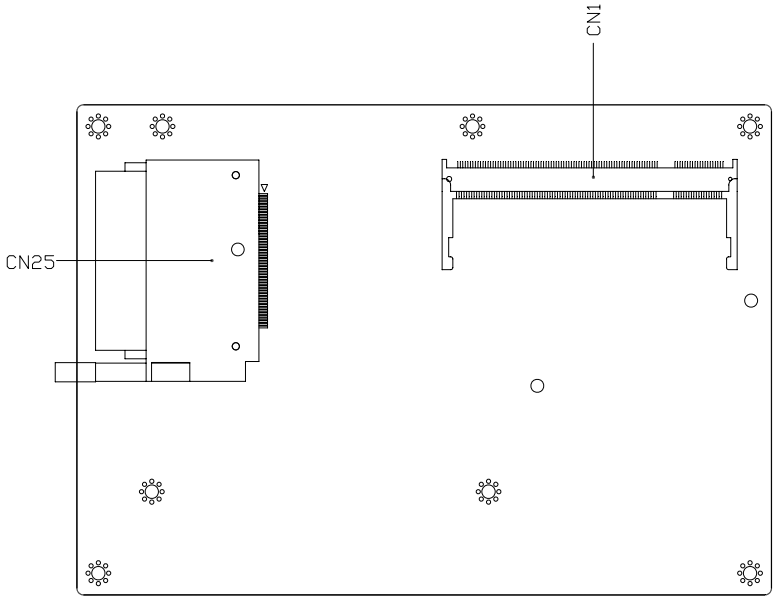

2.3 Mechanical Drawing

Component side

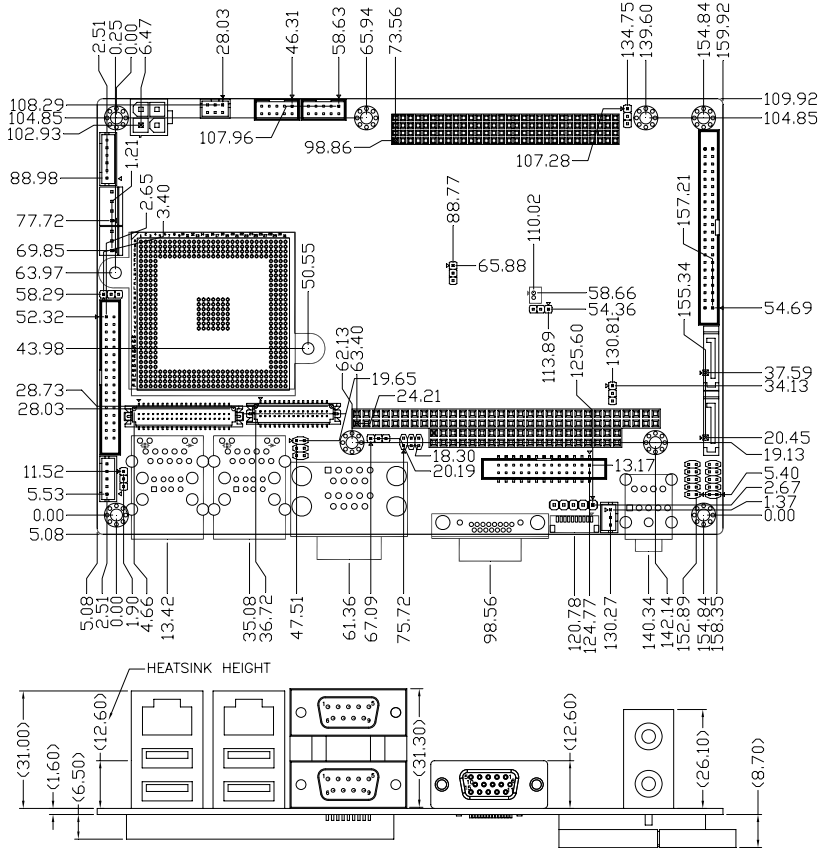

Solder side

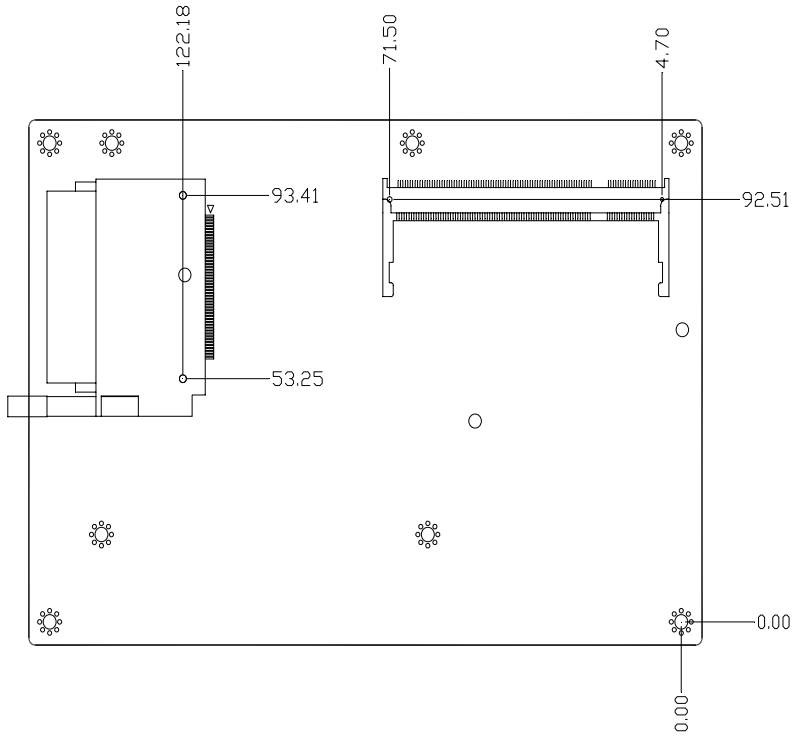

2.4 List of Jumpers

The board has a number of jumpers that allow you to configure your system to suit your application.

The table below shows the function of each of the board's jumpers:

Jumpers

Label	Function
JP1	CFD Mode Selection
JP2	ATX Simulates AT Power
JP3	CMOS Clear Selection
JP4	COM2 +12V/+5V/RING Selection
JP5	LCD Inverter Power Selection
JP6	TTL Clock and LVDS Operating Selection
JP7	Fan Power Selection
JP8	AT/ATX Power Type Selection
JP9	LCD Backlight Control

2.5 List of Connectors

The board has a number of connectors that allow you to configure your system to suit your application. The table below shows the function of each board's connectors:

Connectors

Label	Function
CN1	DDR SODIMM
CN2	LPT Connector
CN3	PC/104 (ISA) Connector
CN4	PCI-104 (PCI) Connector
CN5	COM1/2 Connector
CN6	Power Connector
CN7	USB, LAN Connector
CN8	USB, LAN Connector
CN9	LVDS Connector
CN10	Keyboard/Mouse Connector
CN11	IrDA Connector
CN12	COM3 Connector
CN13	COM4 Connector
CN14	System FAN Connector
CN15	Front Panel Connector
CN16	Digital I/O Connector
CN17	TTL LCD Connector

CN18	LCD Inverter Power Connector
CN19	Floppy Connector
CN20	COM5/GPS Connector
CN21	Power Output Connector
CN23	Audio Connector (Line-in)
CN24	Battery Wafer
CN25	Compact Flash Connector
CN26	IDE Connector
CN27, CN28	SATA Connectors
CN29	VGA Connector
CN30	Standby Power Connector

2.6 Setting Jumpers

You configure your card to match the needs of your application by setting jumpers. A jumper is the simplest kind of electric switch. It consists of two metal pins and a small metal clip (often protected by a plastic cover) that slides over the pins to connect them. To “close” a jumper you connect the pins with the clip.

To “open” a jumper you remove the clip. Sometimes a jumper will have three pins, labeled 1, 2 and 3. In this case you would connect either pins 1 and 2 or 2 and 3.

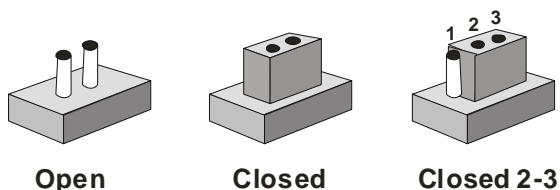

A pair of needle-nose pliers may be helpful when working with jumpers.

If you have any doubts about the best hardware configuration for your application, contact your local distributor or sales representative before you make any change.

Generally, you simply need a standard cable to make most connections.

2.7 CFD1 Selection (JP1)

JP1	Function
2-3	Master mode
1-2	Slave mode (Default)

2.8 ATX Simulates AT Power (JP2)

JP2	Function
2-3	ATX Power
1-2	ATX Power Simulates AT Power (Default)

2.9 CMOS Clear Selection (JP3)

JP3	Function
2-3	Clear CMOS
1-2	Normal (Default)

2.10 COM2 +12V/+5V/Ring Selection (JP4)

JP4	Function
1-2	+12V
3-4	+5V
5-6	Ring (Default)

2.11 LCD Inverter Power Selection (JP5)

JP5	Function
2-3	+5V (Default)
1-2	+12V

2.12 TTL Clock and LVDS Operating Selection (JP6)

JP6	Function
3-5	Inverse Clock
1-3	Normal Clock (Default)
4-6	+3.3V for CN9 (Default)
2-4	+5V for CN9

2.13 Fan Power Selection (JP7)

JP7	Function
2-3	+5V
1-2	+12V (Default)

2.14 AT/ATX Power Type Selection (JP8)

JP8	Function
2-3	AT (Default)
1-2	ATX

2.15 LCD Backlight Control (JP9)

JP9	Function
2-3	+3.3V Level (Default)
1-2	+5V Level

2.16 DDR SODIMM Connector (CN1)

Standard DDR SODIMM Connector

2.17 LPT Connector (CN2)

Pin	Signal	Pin	Signal
1	STB-	2	AFDX
3	PTD0	4	ERRX
5	PTD1	6	PAR_INTX
7	PTD2	8	SLINX
9	PTD3	10	GND
11	PTD4	12	GND
13	PTD5	14	GND
15	PTD6	16	GND
17	PTD7	18	GND
19	ACKX	20	GND
21	BUSY	22	GND
23	PE	24	GND
25	SLCT	26	NC

2.18 PC/104 Connector (CN3)

Standard PC104 ISA Connector

2.19 PCI-104 Connector (CN4)

Standard PCI-104 Connector

2.20 COM1/2 Connector (CN5)

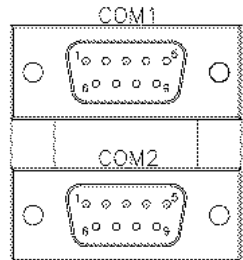

COM1 (Up)

Pin	Signal	Pin	Signal
1	DCD1	2	RXD1
3	TXD1	4	DTR1
5	GND	6	DSR1
7	RTS1	8	CTS1
9	RI1		

COM2 (Down)

Pin	Signal	Pin	Signal
1	DCD2 (422TXD-/485DATA-)	2	RXD2 (422RXD-)
3	TXD2 (422TXD+/485DATA+)	4	DTR2 (422RXD+)
5	GND	6	DSR2
7	RTS2	8	CTS2
9	+12V/+5V/RI2		

2.21 Power Connector (CN6)

Pin	Signal
1	GND

2	GND
3	+12V
4	+12V

2.22 LVDS Connector (CN9)

Pin	Signal	Pin	Signal
1	Backlight enable	2	NC
3	LVDS Power	4	GND
5	TX1CLK#	6	TX1CLK
7	LVDS Power	8	GND
9	TX1OUT#0	10	TX1OUT0
11	TX1OUT#1	12	TX1OUT1
13	TX1OUT#2	14	TX1OUT2
15	TX1OUT#3	16	TX1OUT3
17	NC	18	NC
19	NC	20	NC
21	NC	22	NC
23	NC	24	NC
25	NC	26	NC
27	LVDS Power	28	GND
29	NC	30	NC

2.23 Keyboard/Mouse Connector (CN10)

Pin	Signal	Pin	Signal
1	KDAT	2	KCLK

EPIC Board**EPIC - 5536**

3	GND	4	+5V with fuse
5	MDAT	6	MCLK

2.24 IrDA Connector (CN11)

Pin	Signal
1	+5V
2	NC
3	IRRX
4	GND
5	IRTX

2.25 COM3 Connector (CN12)

Pin	Signal	Pin	Signal
1	DCD3	2	RXD3
3	TXD3	4	DTR3
5	GND	6	DSR3
7	RTS3	8	CTS3
9	RING3	10	NC

2.26 COM4 Connector (CN13)

Pin	Signal	Pin	Signal
1	DCD4	2	RXD4
3	TXD4	4	DTR4
5	GND	6	DSR4
7	RTS4	8	CTS4
9	RING4	10	NC

2.27 System Fan Connector (CN14)

Pin	Signal
1	GND
2	FAN Power
3	FAN_TAC

2.28 Front Panel Connector (CN15)

Pin	Signal	Pin	Signal
1	GND	2	Power Button
3	HD_LED	4	+3.3V
5	BEEP	6	+5V
7	GND	8	Power LED
9	GND	10	Reset

2.29 Digital I/O Connector (CN16)

Pin	Signal	Pin	Signal
1	DIO_1	2	DIO_2
3	DIO_3	4	DIO_4
5	DIO_5	6	DIO_6
7	DIO_7	8	DIO_8
9	+5V with fuse	10	GND

Address: 801H

BIOS Setting	Connector Definition	Address	IT8712F/KX GPIO Setting
DIO_1	CN16 PIN1	Bit 7	U47 PIN20 (GPIO27)

DIO_2	CN16 PIN2	Bit 6	U47 PIN21 (GPIO26)
DIO_3	CN16 PIN3	Bit 5	U47 PIN22 (GPIO25)
DIO_4	CN16 PIN4	Bit 4	U47 PIN23 (GPIO24)
DIO_5	CN16 PIN5	Bit 3	U47 PIN24 (GPIO23)
DIO_6	CN16 PIN6	Bit 2	U47 PIN25 (GPIO22)
DIO_7	CN16 PIN7	Bit 1	U47 PIN26 (GPIO21)
DIO_8	CN16 PIN8	Bit 0	U47 PIN27 (GPIO20)

2.30 TTL LCD Connector (CN17)

Pin	Signal	Pin	Signal
1	+5V	2	+5V
3	GND	4	GND
5	+3.3V	6	+3.3V
7	Backlight enable	8	GND
9	B0	10	B1
11	B2	12	B3
13	B4	14	B5
15	B6	16	B7
17	G0	18	G1
19	G2	20	G3
21	G4	22	G5
23	G6	24	G7
25	R0	26	R1
27	R2	28	R3

EPIC Board		EPIC - 5536	
29	R4	30	R5
31	R6	32	R7
33	GND	34	GND
35	LCD CLOCK	36	LCD VSYNC
37	LCD DE	38	LCD HSYNC
39	NC	40	NC

2.31 LCD Inverter Power Connector (CN18)

Pin	Signal
1	LCD Inverter Power
2	Backlight Control
3	GND
4	GND
5	Backlight enable

2.32 Floppy Connector (CN19)

Pin	Signal	Pin	Signal
1	GND	2	DELSEL#
3	GND	4	NC
5	GND	6	NC
7	GND	8	INDEX#
9	GND	10	MOTEA#
11	GND	12	DRVB#
13	GND	14	DRVA#
15	GND	16	MOTEB#

EPIC Board		EPIC-5536	
------------	--	-----------	--

17	GND	18	DIR#
19	GND	20	STEP#
21	GND	22	WD#
23	GND	24	WE#
25	GND	26	TRAK0#
27	GND	28	WPT#
29	NC	30	RDATA#
31	GND	32	HDSEL#
33	NC	34	DSKCHG#

2.33 COM5/ GPS Connector (CN20)

Pin	Signal
1	NC
2	NC
3	GND
4	GPS LED
5	RXD
6	TXD
7	VCC3.3-BAT.
8	+3.3V
9	NC
10	GND

2.34 Power Output Connector (CN21)

Pin	Signal
1	+12V
2	GND

3	GND
4	+5V

2.35 Audio Line-in Connector (CN23)

Pin	Signal
1	LINE_IN_R
2	Audio GND
3	LINE_IN_L

2.36 Battery Wafer (CN24)

Pin	Signal
1	Battery Power
2	GND

2.37 CompactFlash Connector (CN25)

Standard Compact Flash Connector (Type I & II)

2.38 IDE Connector (CN26)

Pin	Signal	Pin	Signal
1	IDERST	2	GND
3	PID7	4	PID8
5	PID6	6	PID9
7	PID5	8	PID10
9	PID4	10	PID11
11	PID3	12	PID12
13	PID2	14	PID13
15	PID1	16	PID14

EPIC Board		EPIC - 5536	
17	PID0	18	PID15
19	GND	20	NC
21	PDREQ	22	GND
23	PIOW#	24	GND
25	PIOR#	26	GND
27	PRDY	28	Pull 330R to GND
29	PACK#	30	GND
31	PIRQ14	32	NC
33	PPDA1	34	ATA66_DET
35	PPDA0	36	PPDA2
37	PPCS1#	38	PPCS3#
39	HDLED#	40	GND
41	+5V	42	+5V
43	GND	44	NC

2.39 SATA Connector (CN27, 28)

Standard SATA Connector

2.40 VGA Connector (CN29)

Pin	Signal	Pin	Signal
1	R	2	G
3	B	4	NC
5	GND	6	GND
7	GND	8	GND
9	+5V with Fuse	10	GND

11	NC	12	DDC_DAT
13	HSYNC	14	VSYNC
15	DDC_CLK		

2.41 Standby Power Connector (CN30)

Pin	Signal
1	NC
2	GND
3	NC
4	GND
5	PS_ON#
6	+5V Standby

Below Table for China RoHS Requirements
 产品中有毒有害物质或元素名称及含量

AAEON Main Board/ Daughter Board/ Backplane

部件名称	有毒有害物质或元素					
	铅 (Pb)	汞 (Hg)	镉 (Cd)	六价铬 (Cr(VI))	多溴联苯 (PBB)	多溴二苯醚 (PBDE)
印刷电路板 及其电子组件	×	○	○	○	○	○
外部信号 连接器及线材	×	○	○	○	○	○
<p>O: 表示该有毒有害物质在该部件所有均质材料中的含量均在 SJ/T 11363-2006 标准规定的限量要求以下。</p> <p>X: 表示该有毒有害物质至少在该部件的某一均质材料中的含量超出 SJ/T 11363-2006 标准规定的限量要求。</p> <p>备注: 此产品所标示之环保使用期限, 系指在一般正常使用状况下。</p>						

Chapter

3

**Award
BIOS Setup**

3.1 System Test and Initialization

These routines test and initialize board hardware. If the routines encounter an error during the tests, you will either hear a few short beeps or see an error message on the screen. There are two kinds of errors: fatal and non-fatal. The system can usually continue the boot up sequence with non-fatal errors. Non-fatal error messages usually appear on the screen along with the following instructions:

Press <F1> to RESUME

Write down the message and press the F1 key to continue the boot up sequence.

System configuration verification

These routines check the current system configuration against the values stored in the CMOS memory. If they do not match, the program outputs an error message. You will then need to run the BIOS setup program to set the configuration information in memory.

There are three situations in which you will need to change the CMOS settings:

1. You are starting your system for the first time
2. You have changed the hardware attached to your system
3. The CMOS memory has lost power and the configuration information has been erased.

The EPIC-5536 CMOS memory has an integral lithium battery backup for data retention. However, you will need to replace the complete unit when it finally runs down.

3.2 Award BIOS Setup

Awards BIOS ROM has a built-in Setup program that allows users to modify the basic system configuration. This type of information is stored in battery-backed CMOS RAM so that it retains the Setup information when the power is turned off.

Entering Setup

Power on the computer and press immediately. This will allow you to enter Setup.

Standard CMOS Features

Use this menu for basic system configuration. (Date, time, IDE, etc.)

Advanced BIOS Features

Use this menu to set the advanced features available on your system.

Advanced Chipset Features

Use this menu to change the values in the chipset registers and optimize your system performance.

Integrated Peripherals

Use this menu to specify your settings for integrated peripherals. (keyboard, mouse etc.)

Power Management Setup

Use this menu to specify your settings for power management. (HDD power down, power on by ring, KB wake up, etc.)

PnP/PCI Configurations

This entry appears if your system supports PnP/PCI.

PC Health Status

Use this menu to set PC Health Status.

Frequency/Voltage Control

Use this menu to specify your settings for auto detect DIMM/PCI clock and spread spectrum.

Load Optimized Defaults

Use this menu to load the BIOS default values that are factory settings for optimal performance system operations. While AWARD has designated the custom BIOS to maximize performance, the factory has the right to change these defaults to meet their needs.

Set Password

Use this menu to set Supervisor Password.

Save and Exit Setup

Save CMOS value changes to CMOS and exit setup.

Exit Without Saving

Abandon all CMOS value changes and exit setup.

You can refer to the "AAEON BIOS Item Description.pdf" file in the CD for the meaning of each setting in this chapter.

Chapter

4

**Driver
Installation**

The EPIC-5536 comes with a CD-ROM that contains all drivers and utilities that meet your needs.

Follow the sequence below to install the drivers:

- Step 1 – Install LX-Graphics Driver
- Step 2 – Install AES Driver
- Step 3 – Install PCI to ISA Bridge Driver
- Step 4 – Install LAN Driver
- Step 5 – Install AMD Audio Driver
- Step 6 – Install Realtek Audio Driver
- Step 7 – Install VRAID Driver

USB 2.0 Drivers are available for download using Windows Update for both Windows XP and Windows 2000. For additional information regarding USB 2.0 support in Windows XP and Windows 2000, please visit www.microsoft.com/hwdev/usb/.

Please read instructions below for further detailed installations.

4.1 Installation:

Insert the EPIC-5536 CD-ROM into the CD-ROM Drive. And install the drivers from Step 1 to Step 7 in order.

Step 1 –Install LX-Graphic Driver

1. Click on **Start** button
2. Click on **Settings** button
3. Click on **Control Panel** button
4. Click on **System** button
5. Select **Hardware** and click on **Device Manager...**
6. Double click on **Video Controller (VGA Compatible)**
7. Click on **Update Driver...**
8. Click on **Next**
9. Select **Search for a suitable driver...**, then click on **Next**
10. Select **Specify a location**, then click on **Next**
11. Click on **Browse**
12. Select “**lx_win**” file from CD-ROM (**Driver/Step 1 – LX-Graphics**) then click on **Open**
13. Click on **OK**
14. Click on **Next**
15. Click on **Yes**
16. Click on **Finish**

Step 2 –Install AES Driver

1. Click on **Start** button
 2. Click on **Settings** button
-

3. Click on **Control Panel** button
4. Click on **System** button
5. Select **Hardware** and click on **Device Manager...**
6. Double click on **Entertainment Encryption/Decryption Controller**
7. Click on **Update Driver...**
8. Click on **Next**
9. Select **Search for a suitable driver...**, then click on **Next**
10. Select **Specify a location**, then click on **Next**
11. Click on **Browse**
12. Select "**LXAES**" file from CD-ROM (**Driver/Step 2 – AES**) then click on **Open**
13. Click on **OK**
14. Click on **Next**
15. Click on **Yes**
16. Click on **Finish**

Step 3 –Install PCI to ISA Bridge Driver

1. Click on **Start** button.
2. Click on **Settings** button
3. Click on **Control Panel** button
4. Click on **System** button
5. Select **Hardware** and click on **Device Manager...**
6. Double click on **Other PCI Bridge Device**
7. Click on **Update Driver...**

8. Click on **Next**
9. Select **Search for a suitable driver...**, then click on **Next**
10. Select **Specify a location**, then click on **Next**
11. Click on **Browse**
12. Select "Ite" file from CD-ROM (**Driver/Step 3- PCI to ISA Bridge**) then click on **open**
13. Click on **OK**
14. Click on **Next**
15. Click on **Yes**
16. Click on **Finish**

Step 4 – Install LAN Driver

1. Click on the **Step 4 –LAN** folder and Double click on **Setup.exe**
2. Follow the instructions that the window shows
3. The system will help you install the driver automatically

Step 5– Install AMD Audio Driver

1. Click on **Start** button
2. Click on **Settings** button
3. Click on **Control Panel** button
4. Click on **System** button
5. Select **Hardware** and click on **Device Manager...**
6. Double click on **Multimedia Audio Controller**
7. Click on **Update Driver...**

8. Click on **Next**
9. Select **Search for a suitable driver...**, then click on **Next**
10. Select **Specify a location**, then click on **Next**
11. Click on **Browse**
12. Select “**LXWDMAu**” file from CD-ROM (**Drivers/Step 5 – AMD Audio Driver**) then click on **Open**
13. Click on **OK**
14. Click on **Next**
15. Click on **Yes**
16. Click on **Finish**

Step 6 – Install Realtek Audio Driver

1. Click on the **Step 6 –Realtek audio driver** folder and
Double click on **WDM_A400.exe**
2. Follow the instructions that the window shows
3. The system will help you install the driver automatically

Step 7 – Install VRAID Driver

Please follow the application note to install the **Step 7-VRAID_Driver_V5508**

Application Note:

Window Operating System cannot recognize the driver of chip VT6421 and treat it as a third-part driver. Please follow below steps to install the driver with Operating System.

1. Creating a Drive Disk: copy the SATA driver from AAEON CD to floppy disk before install OS.

- Click on **Step 7-VRAID_Driver_V5508**
- Click on **VRAIDrv** (see below picture)

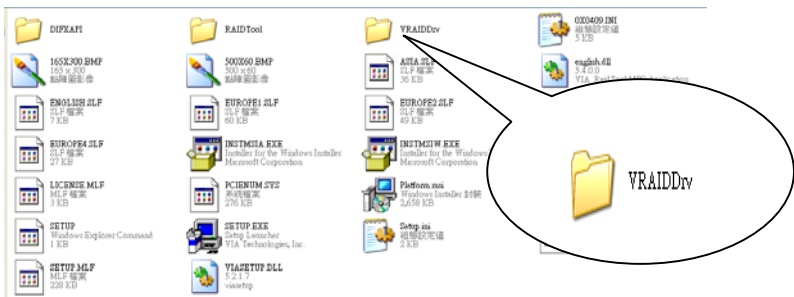

- Click on **DriverDiskPrep.exe** (see below picture)

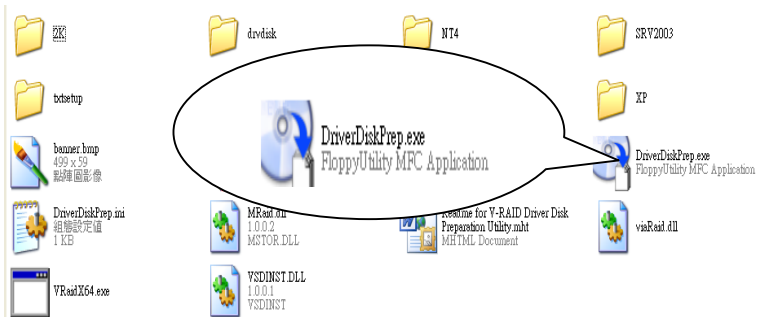

- Click on the OS what you are going to install.

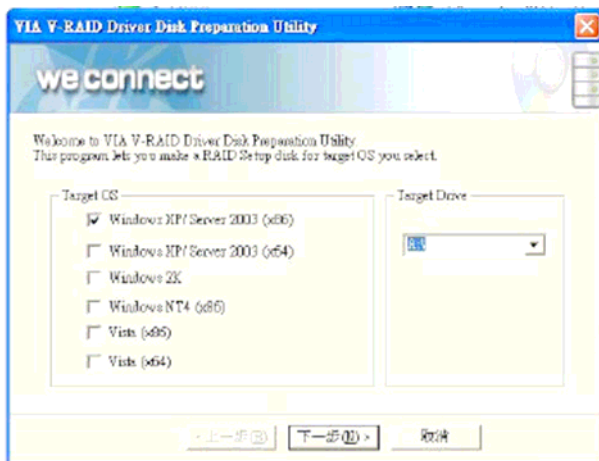

- Install Floppy or USB Floppy

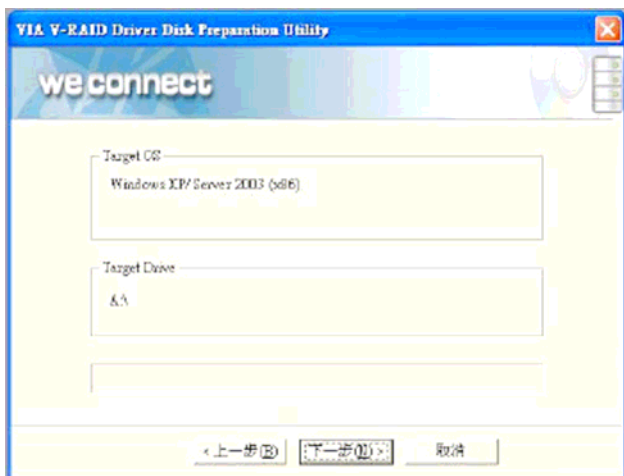

- Finish: driver disk ready.

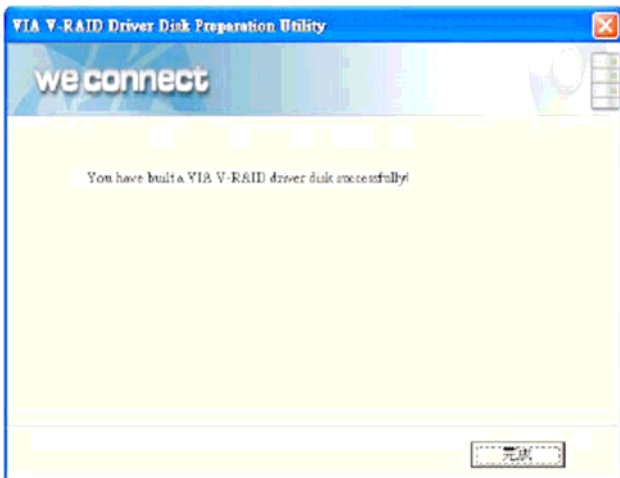

2. Following are the raid configuration steps.

- A. Press <Tab> key to enter Raid BIOS setup
(Raid BIOS only enable when SATA HDD connected)

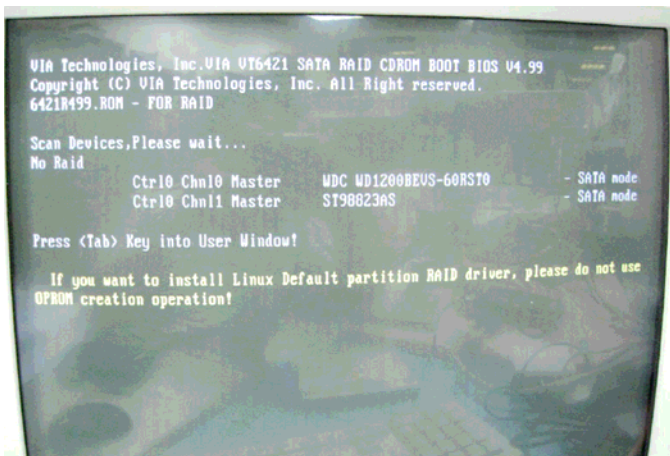

B. Create Array

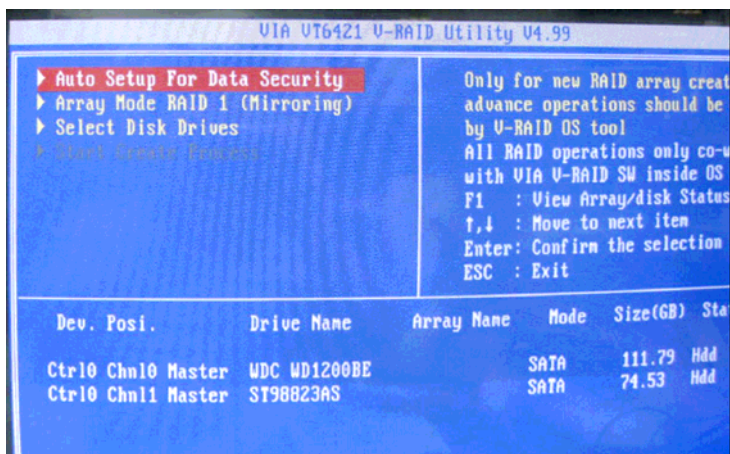
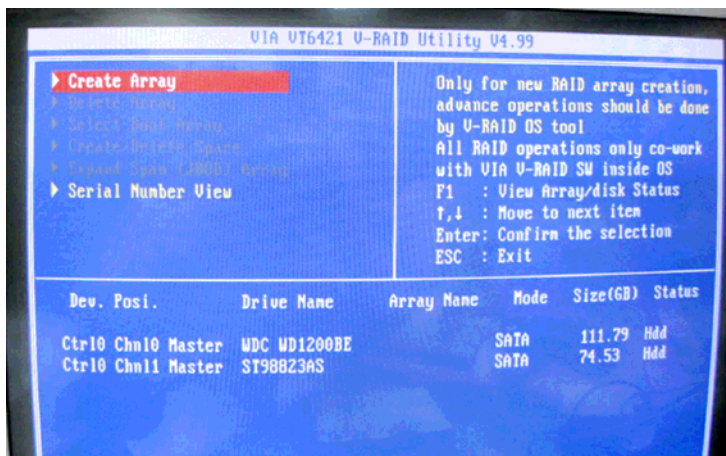

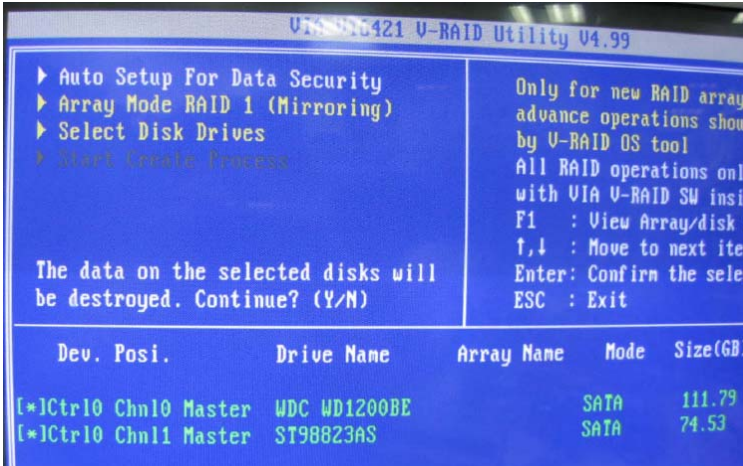

C. After Raid has been created, set this array bootable.

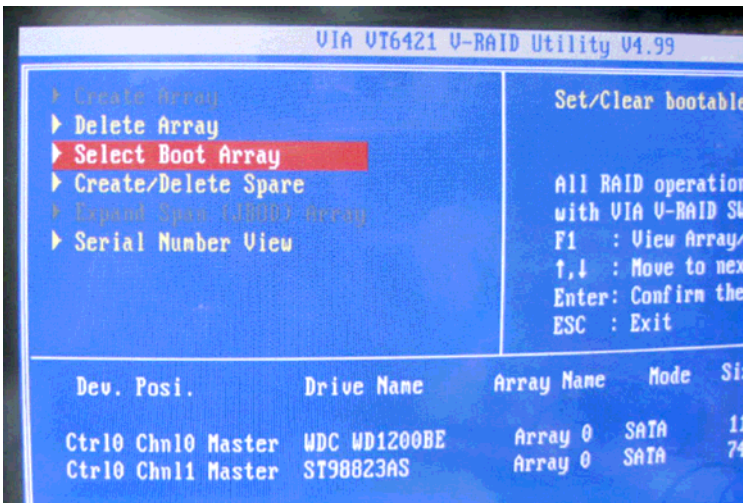

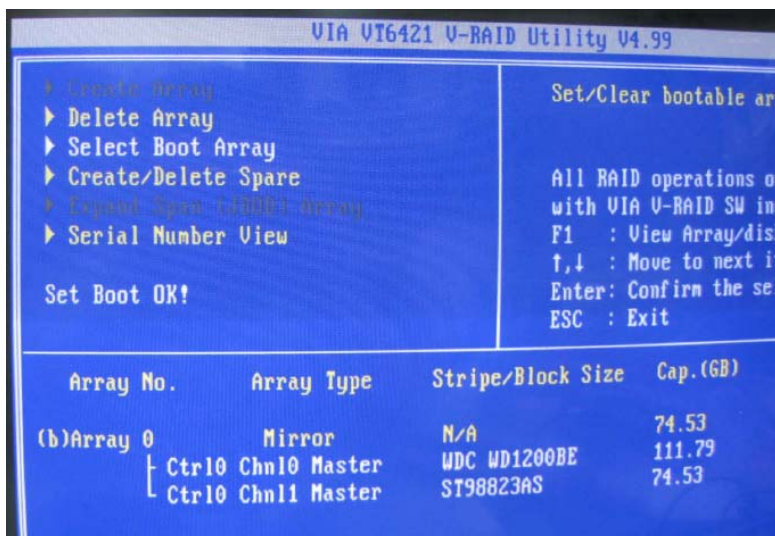
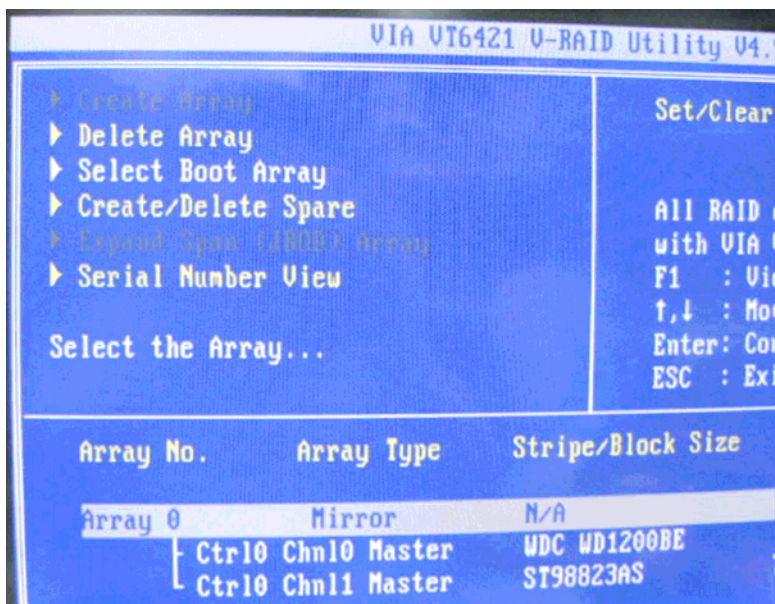

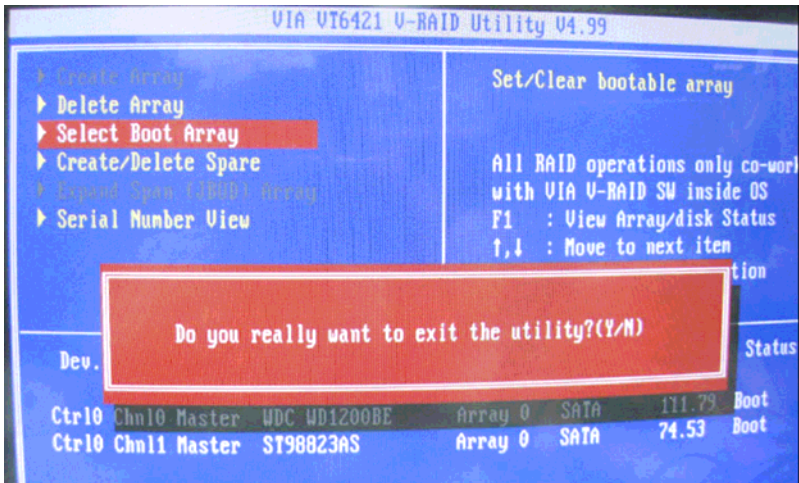

D. Now the Raid Array is ready for OS installation

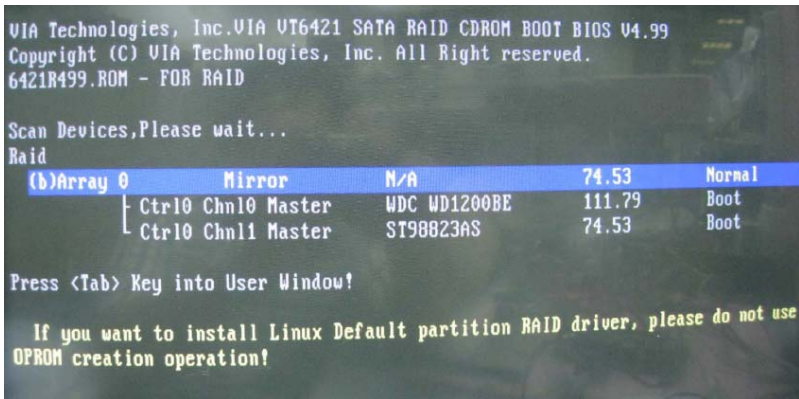

3. Insert your Windows CD, and then restart the computer
4. Follow the on-screen instructions to begin the Windows installation.
5. When prompted to install a third-party driver, press **F6**.

Note: When F6 is active, a prompt appears at the bottom of the screen for only 5 seconds. If you miss your chance to press F6, restart your computer.

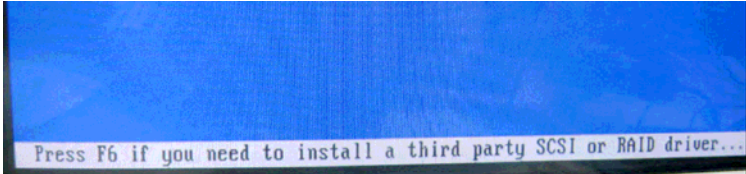

6. Insert the driver disk, and then wait until you are prompted to install a driver.

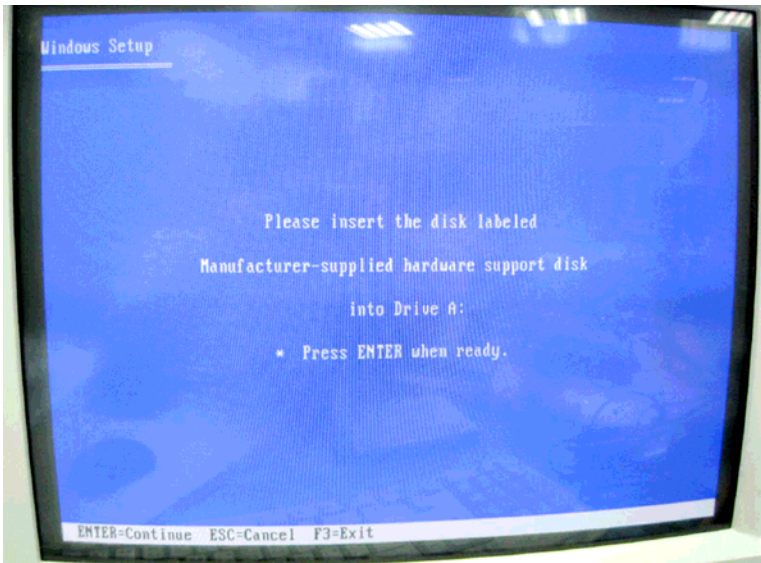

7. Press **S** to specify the driver is on a floppy disk, and then press **Enter**.



8. The computer reads the disk
9. When the SATA driver is found, press **Enter**.

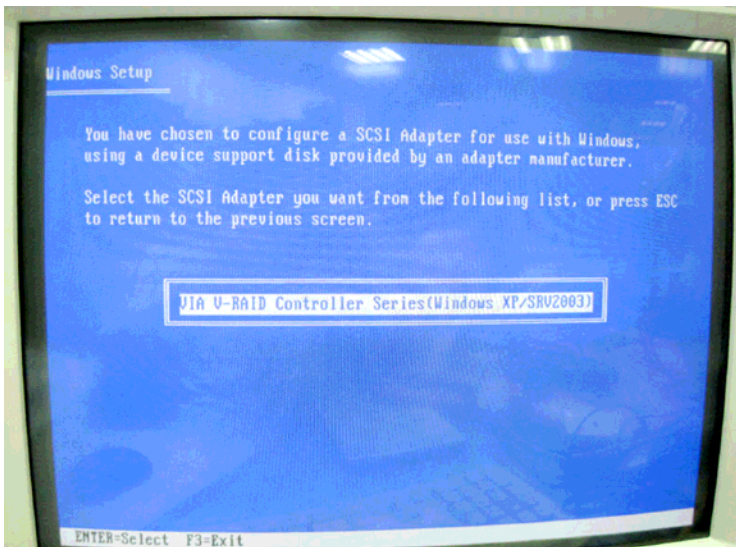

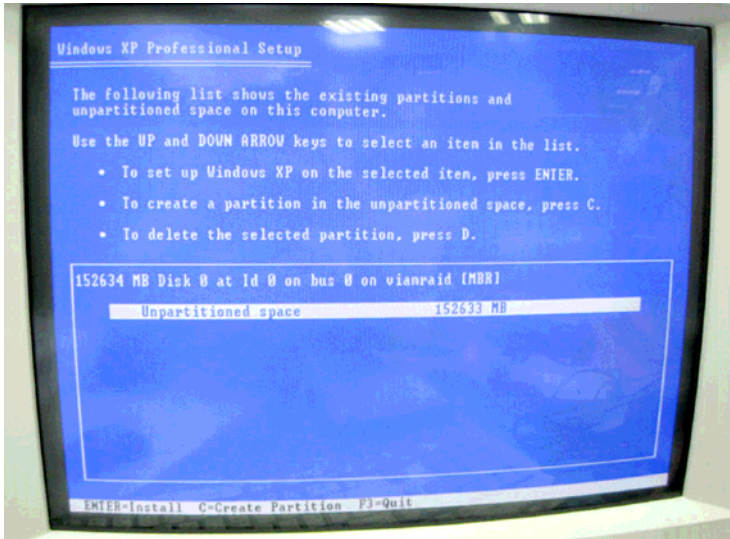

10. Follow the on-screen instructions to complete the installation. After finish installing OS, you have to install VIA Raid management Utility.

Setup RAID Management

- A. Click on **Step 7-VRAID_Driver_V5508**
- B. Click on **SETUP.exe** (see below picture)
- C. Follow the instructions that the window shows
- D. The system will help you install the driver automatically

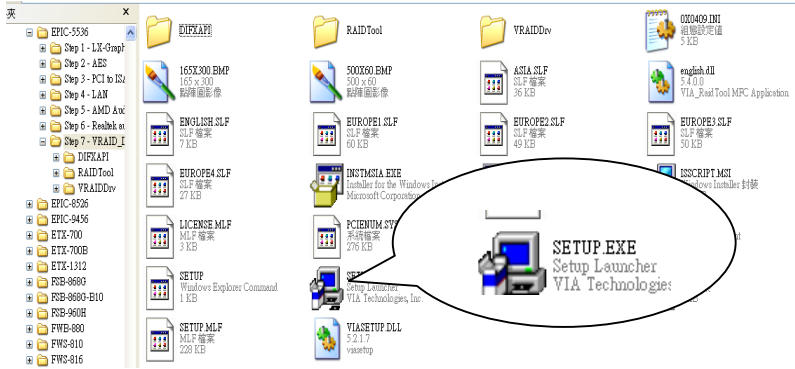

Appendix

A

Programming the Watchdog Timer

A.1 Programming

EPIC-5536 utilizes ITE 8712 chipset as its watchdog timer controller. (K version)

Below are the procedures to complete its configuration and the AAEON initial watchdog timer program is also attached based on which you can develop customized program to fit your application.

Configuring Sequence Description

After the hardware reset or power-on reset, the ITE 8712 enters the normal mode with all logical devices disabled except KBC.

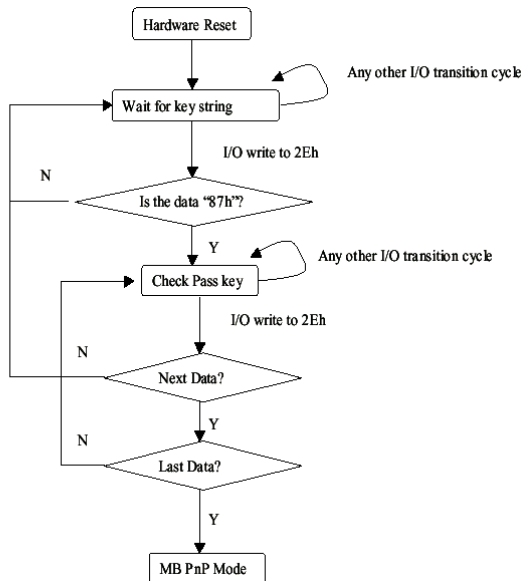

There are three steps to complete the configuration setup: (1) Enter the MB PnP Mode; (2) Modify the data of configuration registers; (3)

Exit the MB PnP Mode. Undesired result may occur if the MB PnP Mode is not exited normally.

(1) Enter the MB PnP Mode

To enter the MB PnP Mode, four special I/O write operations are to be performed during Wait for Key state. To ensure the initial state of the key-check logic, it is necessary to perform four write operations to the Special Address port (2EH). Two different enter keys are provided to select configuration ports (2Eh/2Fh) of the next step.

	Address Port	Data Port
87h, 01h, 55h, 55h:	2Eh	2Fh

(2) Modify the Data of the Registers

All configuration registers can be accessed after entering the MB PnP Mode. Before accessing a selected register, the content of Index 07h must be changed to the LDN to which the register belongs, except some Global registers.

(3) Exit the MB PnP Mode

Set bit 1 of the configure control register (Index=02h) to 1 to exit the MB PnP Mode.

WatchDog Timer Configuration Registers

LDN	Index	R/W	Reset	Configuration Register or Action
All	02H	W	N/A	Configuration Control
07H	71H	R/W	00H	WatchDog Timer Control Register
07H	72H	R/W	00H	WatchDog Timer Configuration Register
07H	73H	R/W	00H	WatchDog Timer Time-out Value (LSB) Register
07H	74H	R/W	00H	WatchDog Timer Time-out Value (MSB) Register

Configure Control (Index=02h)

This register is write only. Its values are not sticky; that is to say, a

hardware reset will automatically clear the bits, and does not require the software to clear them.

Bit	Description
7-2	Reserved
1	Returns to the Wait for Key state. This bit is used when the configuration sequence is completed.
0	Resets all logical devices and restores configuration registers to their power-on states.

WatchDog Timer Control Register (Index=71h, Default=00h)

Bit	Description
7	WDT is reset upon a CIR interrupt
6	WDT is reset upon a KBC (Mouse) interrupt
5	WDT is reset upon a KBC (Keyboard) interrupt
4	WDT is reset upon a read or a write to the Game port base address
3-2	Reserved
1	Force Time-out. This bit is self-clearing
0	WDT status 1: WDT value reaches 0 0: WDT value is not 0

WatchDog Timer Configuration Register (Index=72h, Default=00h)

Bit	Description
7	WDT Time-out value select 1: Second 0: Minute
6	WDT output through KRST (pulse) enable
5	WDT Time-out value Extra select 1: 4s. 0: Determine by WDT Time-out value select (bit7 of this register)
4	WDT output through PWROK1/PWROK2 (pulse) enable
3	Select the interrupt level ^{note} for WDT

WatchDog Timer Time-out Value (LSB) Register (Index=73h,**Default=00h)****Bit Description**

Bit	Description
7-0	WDT Time-out value 7-0

WatchDog Timer Time-out Value (MSB) Register (Index=74h,**Default=00h)****Bit Description**

Bit	Description
7-0	WDT Time-out value 15-8

A.2 ITE8712 Watchdog Timer Initial Program

```
.MODEL SMALL
```

```
.CODE
```

Main:

```
CALL Enter_Configuration_mode
```

```
CALL Check_Chip
```

```
mov cl, 7
```

```
call Set_Logic_Device
```

```
;time setting
```

```
mov cl, 10 ; 10 Sec
```

```
dec al
```

Appendix

B

I/O Information

B.1 I/O Address Map

Address	Description	User Address
000-01F	DMA Controller #1	000-000F
020-03F	Interrupt Controller #1, Master	020-021
040-05F	System Time	040-043
060-06F	8042 (Keyboard Controller)	060-064
070-07F	Real time Clock, NMI (non-maskable Interrupt) Mask	070-073
080-09F	DMA Page Register	080-08F
0A0-0BF	Interrupt Controller #2	0A0-0A1
0C0-0DF	DMA Controller #2	0C0-0DF
0F0-0FF	Math Coprprocessor	0F0-0FF
1F0-1F7	Primary IDE Channel	1F0-1F7
2E8-2EF	Serial Port 4	2E8-2EF
2F8-2FF	Serial Port 2	2F8-2FF
378-37F	Parallel Printer Port 1	378-37F
3B0-3DF	EGA / VGA card	3B0-3DF
3E8-3EF	Serial Port 3	3E8-3EF
3F8-3FF	Serial Port 1	3F8-3FF

B.2 1st MB Memory Address Map

Memory Address	Description
00000-9FFFF	System memory
A0000-BFFFF	VGA buffer
C0000-CBFFF	VGA BIOS
E0000-FFFFF	System BIOS

B.3 IRQ Mapping Chart

IRQ0	System Timer	IRQ8	System CMOS / Real time clock
IRQ1	Keyboard	IRQ9	Microsoft ACPI – Compliant system
IRQ2	Cascade to IRQ Controller	IRQ10	COM3
IRQ3	COM2	IRQ11	COM4
IRQ4	COM1	IRQ12	PS/2 mouse
IRQ5	Unused	IRQ13	FPU
IRQ6	Floppy	IRQ14	Primary IDE
IRQ7	Printer	IRQ15	Reserved

B.4 DMA Channel Assignments

DMA Channel	Function
0	Available
1	Available
2	Floppy
3	Available

Appendix

C

Mating Connector

C.1 List of Mating Connectors and Cables

The table notes mating connectors and available cables.

Connector Label	Function	Mating Connector		Available Cable	Cable P/N
		Vendor	Model no		
CN2	LPT Connector	Astron	2.0mm Pitch 26 pins (Astron 27-24041-213-1G-TB1-R or compatible)	LPT cable	1701260200
CN9	LVDS Connector	E-call	1.25mm Pitch 30 pins (E-call 0110-01-553-300 or compatible)	LVDS cable	N/A
CN10	Keyboard/Mouse Connector	Ho-base	2.0mm Pitch 6 pins (Ho-base 2005-2WS-6 or compatible)	Keyboard /Mouse cable	1700060152
CN11	IrDA Connector	Ho-base	2.0mm Pitch 6 pins	IrDA cable	N/A
CN12	COM3 Connector	Catch	2.0mm Pitch 10 pins (Catch 1147-000-10S or compatible)	COM cable	1701100206
CN13	COM4 Connector	Catch	2.0mm Pitch 10 pins (Catch 1147-000-10S or compatible)	COM cable	1701100206
CN14	System FAN Connector	Catch	2.54mm Pitch 3 pins (CATCH 1190-700-03S or compatible)	FAN cable	N/A
CN15	Front Panel Connector	Ho-base	2.0mm Pitch 10 pins	Front Panel Cable	N/A
CN16	Digital I/O Connector	Ho-base	2.0mm Pitch 10 pins	Digital I/O cable	N/A

CN17	TTL LCD Connector	e-call	1.25mm Pitch 40 pins (e-call.0110-01-55 3-400 or compatible)	TFT LCD cable	N/A
CN18	LCD Inverter Power Connector	Catch	2.0mm Pitch 5 pins (CATCH 1192-700-05S or compatible)	LCD Inverter cable	N/A
CN19	Floppy Connector	Catch	2.0mm Pitch 34 pins (Catch 1147-00-34S or compatible)	Floppy cable	1701340703
CN20	COM5/GPS connector	Catch	1.0mm Pitch 10 pins (Catch 1204-700-10SM or compatible)	COM5/G PS cable	N/A
CN21	Power Output Connector	Catch	2.54mm Pitch 10 pins (Catch 1190-700-04S or compatible)	Power output cable	N/A
CN23	Audio Connector (Line-in)	Catch	2.0mm Pitch 3 pins (Catch 1192-700-03S or compatible)	Audio Connector cable	N/A
CN26	Primary EIDE Connector	Catch	2.0mm Pitch 44 pins (Catch 1147-000-44S or compatible)	IDE cable	1701440500
CN30	Stand by power Connector	Catch	2.0mm Pitch 6 pins (CATCH.1192-700-06SA or compatible)	Stand by power cable	N/A